



TECHNICAL
SPECIFICATIONS

Product Code	PM2050-HI99-TAH
Dimension (mm) W x L x H	18,5x18,5x8,5
Material	PMMA- ABS
Fastening	Tape
Beam Angle	20° - 50°
Type	1
Optical Efficiency	%93
Rohs Complaint	Yes

MATERIALS

PMMA clear, Non-yellowing for 10 years.
Yellowness Index (YI) according to the test standarts for Arizona/Florida outdoor exposure testing:
-YI 6 under hot/dry conditions
-YI 8 under hot/wet conditions

INSTRUCTIONS FOR USE &
MAINTENANCE

Working Temperature : -40° C ~ +100° C
Storage Temperature : -40° C ~ +100° C
Please handle or install lenses with wearing gloves.
Skin oils may damage lens or its optical characteristic.
Never use any commercial cleaning solvents on lenses , like alcohol.
If necessary, clean lenses wiht mild soap, water and soft cloth.

CREE J3030

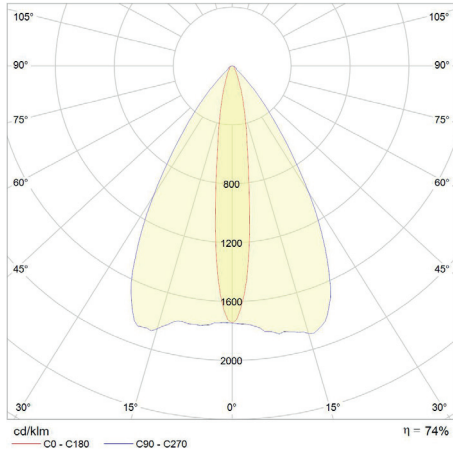

OSRAM DURIS S5

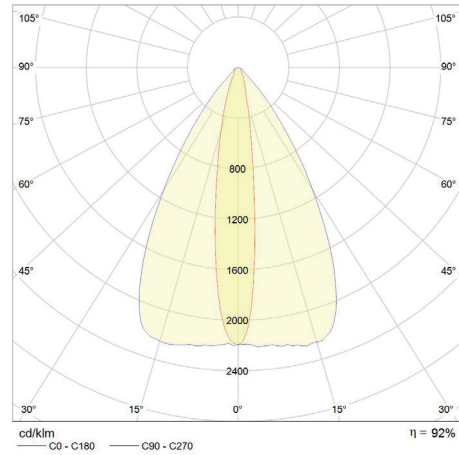

SAMSUNG 302Z

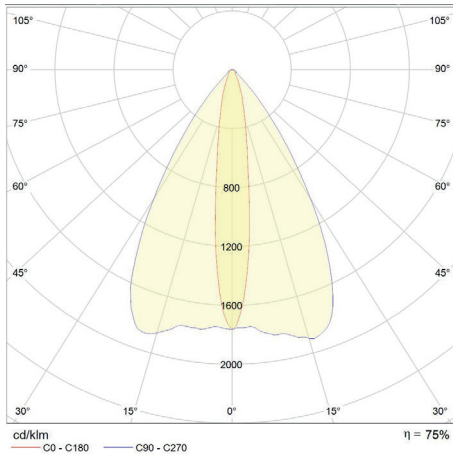

OSRAM OSOLON SQUARE

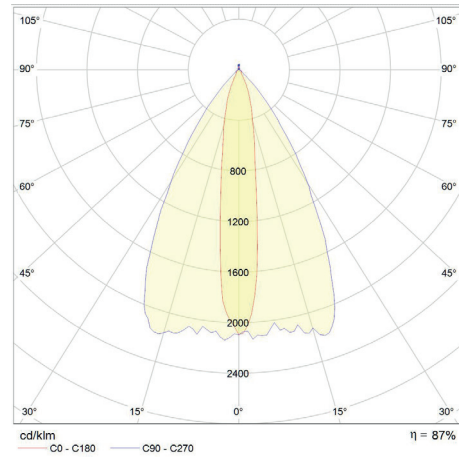

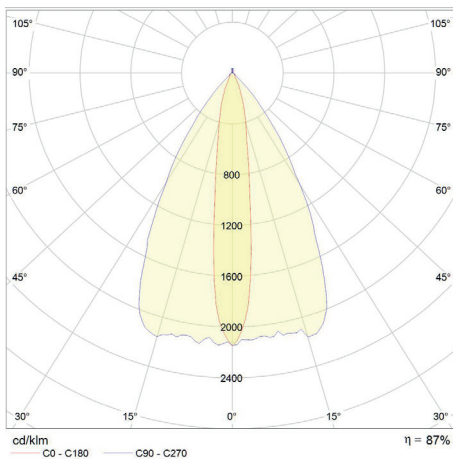

CREE XTE

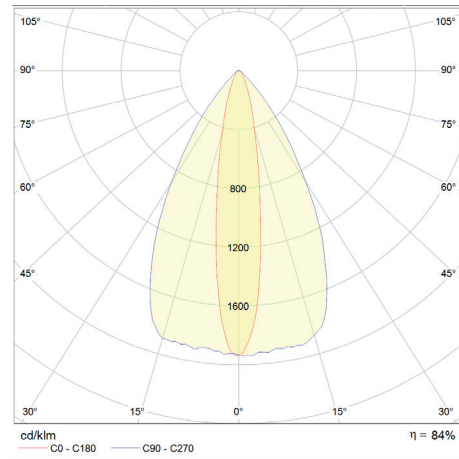

SEOUL Z5-M3

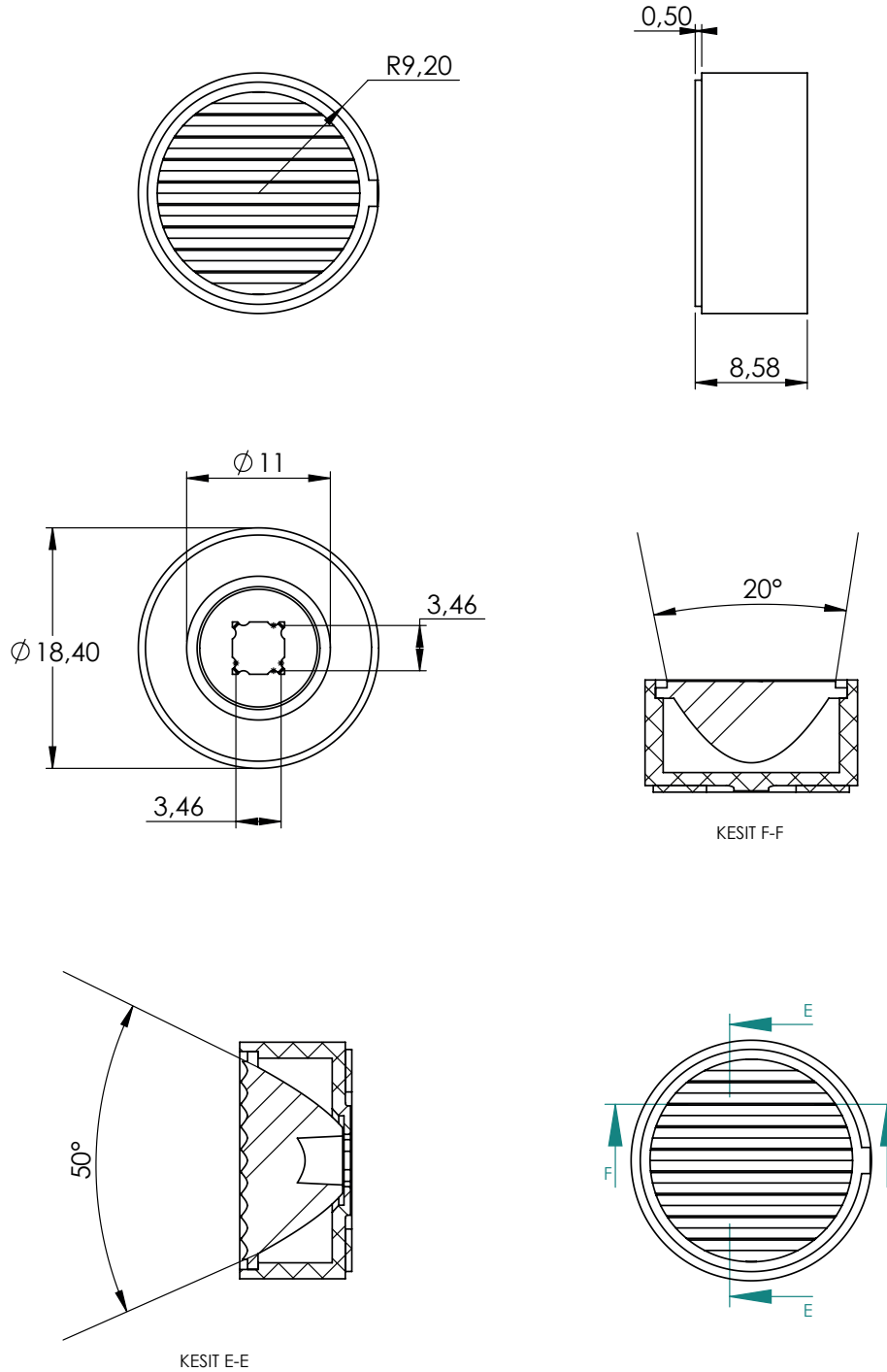

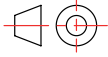

	UNIT mm	PART NO: PM2050-HI99-TAH	 GENERAL TOLERANCES $\pm 0,2$ MM	
	MATERIAL	PMMA - ABS	REV.	REVISION
	WEIGHT	1,69 g	1	
	DATE	22.06.2020	2	
		3		
		PAGE 1 / 1	FORM A4	SCALE 2:1

Box Size (mm) W x L x H	130x130x125
Box Weight	0,6 Kg
Box Quantity	325 pcs

